

RESEARCH ARTICLE

Advancing Security Measures: A Brainwave-Based Biometric System for User Identification and Authentication

Muhammad Nur Arif Mohd Farid¹, Md Mahmudul Hasan¹, Norizam Sulaiman^{1,*}, Mahfuzah Mustafa¹ and Siti Armiza Mohd Aris²

¹ Faculty of Electrical and Electronic Engineering Technology, Universiti Malaysia Pahang Al-Sultan Abdullah, 26600, Pekan, Pahang, Malaysia

² Razak Faculty of Technology and Informatics, Universiti Teknologi Malaysia, 54100, Kuala Lumpur, Malaysia

ABSTRACT - In contemporary organizational contexts, the imperative for robust user identification and authentication systems to safeguard assets is paramount. Conventional methods like passwords, secret codes, and personal identification numbers are prone to compromise and human error. This study explores the feasibility of utilizing human brainwaves, specifically Electroencephalogram (EEG) signals, as a biometric authentication system. Employing the Unicorn Hybrid Black EEG device for measurement and LabVIEW software for analysis, the research focuses on discerning EEG features pertinent to authentication. Through controlled activities encompassing imaginative (imagining singing a favorite song, imagining opening a locked door) and physical tasks (engaging in a mobile game, solving a Rubik's cube), the study elucidates the dominance of the EEG Theta band across varied cognitive and motor processes. Further analysis underscores the heightened power of the EEG Alpha band during relaxation phases and the prevalence of the EEG Beta band during heightened cognitive engagement. The classification of selected EEG features highlights the efficacy of utilizing Standard Deviation as a discriminative factor, achieving a commendable accuracy of 93.35% with a training-testing ratio of 80:20. This research underscores the potential of EEG-based authentication systems in fortifying organizational security protocols.

ARTICLE HISTORY

Received : 6th Jan 2024
 Revised : 25th April 2024
 Accepted : 29th April 2024
 Published : 4th May 2024

KEYWORDS

Biometric Identification
Biometric Authentication
EEG Signal
LabVIEW
Security Protocols

1.0 INTRODUCTION

Password-based authentication systems have been viewed as a significant problem for organizations hoping to safely and frictionlessly authenticate. Methods of identification and authentication such as passwords, secret codes, and personal identification numbers are vulnerable to being cracked and can also be easily forgotten, exchanged, observed, or stolen. The use of biometrics is a potential option that might be considered for determining the identities of users. However, some people may be unable to use common biometric authentication methods due to physical limitations, such as not having fingerprints or facial features that can be recognized by the system [1]. The use of brainwaves as a form of biometric verification offers various benefits, the primary one being that they cannot be copied or stolen. Brainwaves are measured using an electroencephalogram (EEG) and are classified into several different types, including alpha, beta, delta, and gamma waves as shown in Table 1. Brainwave frequencies are categorized into different bands based on their frequency ranges. These bands include Delta (< 4 Hz), Theta (4 – 7 Hz), Alpha (8 – 16 Hz), Beta (17 – 30 Hz), and Gamma (> 30 Hz). Each band is associated with specific mental states and functions. Delta waves are observed during deep sleep, Theta waves during light sleep, meditation, and creativity, Alpha waves during relaxation, meditation, and learning, Beta waves during normal waking state and focus, and Gamma waves during high-level information processing, memory improvement, and sudden insights. Understanding these band types helps comprehend various mental states and activities related to each frequency range. Brainwaves band frequency range taken from 0.5 to 50 Hz.

Table 1. Brainwaves classification and description

Band type	Frequency range	Description
Delta	< 4 Hz	Deep sleep
Theta	4 – 7 Hz	Light sleep, deep meditation, creative, recall, fantasy
Alpha	8 – 16 Hz	Relax, light meditation, creative, conscious, learning
Beta	17 – 30 Hz	Normal wake, concentration, focus
Gamma	> 30 Hz	Cognitive learning, information processing

Brainwave signal analysis and authentication can be done with LabVIEW software. It can acquire, process, visualize, and control signals and devices. It can analyze brainwave signals because of its many built-in functions and libraries for signal processing, data analysis, and display [2]. LabVIEW are used to construct unique user interfaces and control systems for brainwave signal studies [3]. MATLAB are used to find feature classification using the K-Nearest Neighbors (KNN) method.

The study aims to implement a brainwave-based biometric system for user identification and authentication using LabVIEW. To accomplish this goal, several sub-objectives will be pursued. Firstly, the study aims to investigate the optimal EEG features that can be utilized in authentication systems. Secondly, it seeks to analyse and identify the most suitable activities for users in an EEG-based identification and authentication system. Lastly, the study aims to develop a triggering or feedback system within a specific device during the process of EEG identification and authentication. By addressing these sub-objectives, the study aims to achieve the overall goal of implementing a robust and effective brainwave-based biometric system using LabVIEW.

2.0 LITERATURE REVIEW

Brainwave-based biometrics, also known as electroencephalography (EEG) biometrics, is a relatively new area of research that utilizes the unique patterns in an individual's brainwaves as a means of identification and authentication [4]. EEG signals are considered a promising biometric modality because they are unique to each individual, and they can be easily acquired using non-invasive techniques [5].

Several studies have been conducted to evaluate the feasibility of using EEG signals for user identification and authentication. A study based on EEG signals using Gamma band power to develop a brainwave-based biometric authentication system is conducted in [6], with an equal error rate of 0.0196. Another study proposed an online biometric authentication system in [7], they used EEG signals to develop a brainwave-based authentication system and utilized subject-specific band power features, achieved 88.33% accurate result. There are several EEG-based feature extraction methods that have been proposed to extract relevant information from EEG signals for identification and authentication. These methods include time-frequency analysis, independent component analysis, and machine learning techniques. An EEG-based biometric system developed in [8], utilizing CNN with an accuracy of 88%. Another biometric authentication system is proposed in [9], utilizing 14 channels of EEG data and visual and audio stimuli. They employed PSD as their feature extraction technique and achieved an accuracy of 79.73%.

However, there are also some limitations to the use of EEG signals for user identification and authentication. One of the main challenges is the high variability in EEG signals between individuals and even for the same individual at different times. Additionally, the use of EEG signals raises concerns about privacy and security [10].

The literature suggests that the use of EEG signals for user identification and authentication is a promising area of research with the potential for high accuracy. Several EEG-based feature extraction methods have been proposed, and they have been shown to be effective in different applications. The benefits of machine learning, and deep learning, have spurred substantial development in the field of EEG applications and identifications [11 - 12]. However, current EEG-based identification and authentication systems are not capable of accurately detecting and responding to EEG signals, providing real-time feedback to the user. The use of a proper device will improve the reliability, accuracy, and user experience of EEG-based identification and authentication processes through the integration of a triggering or feedback mechanism. In considering this, we decided to conduct this investigation using the KNN model to address the limitations and concerns surrounding the use of EEG signals for user identification and authentication.

3.0 METHODOLOGY

The comprehensive design of the current investigation system is shown in Figure 1, which illustrates the sequential processing steps performed on the collected EEG data from participants for biometric identification and authentication.

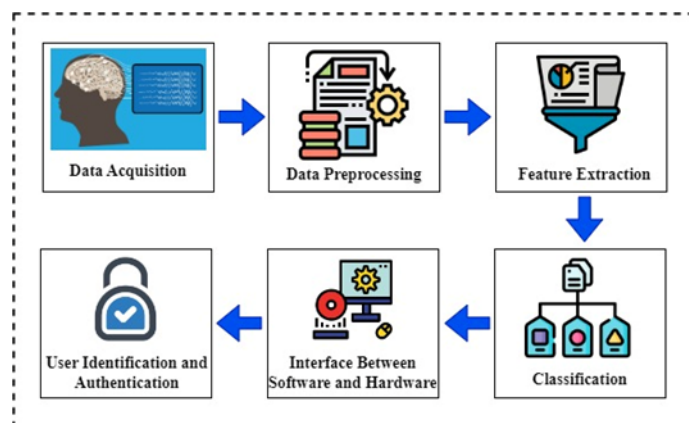

Figure 1. Comprehensive overview of the current study

3.1 Flowchart Of The Study

The project involves the implementation of an online brainwave-based biometric system for user identification and authentication, as detailed in Figure 2 of the flowchart. The EEG device, specifically the Unicorn Hybrid Black, is set up to capture brain signals. Testing is performed to ensure the proper functioning of the EEG device and sensors. If successful, the experiment proceeds, and the subjects' EEG data is recorded three times to enhance accuracy. The recorded data is imported into LabVIEW for pre-processing, including noise elimination and filtering within specific frequency limits. Spectral analysis is conducted to examine the frequency distribution of the signals. Relevant features are extracted and selected for analysis, including mean, standard deviation, and spectral centroid. Feature classification is performed using the KNN algorithm, and the accuracy of the classifier is evaluated. If the accuracy exceeds 90%, a graphical user interface (GUI) is developed in LabVIEW, displaying appropriate messages and LED indicators for user access. Hardware development includes a door lock solenoid, red LED for a closed door, and green LED for an open door. Thorough testing ensures adherence to specifications and standards. If successful, the system greets the user and unlocks the door; otherwise, access is denied, and the door remains locked.

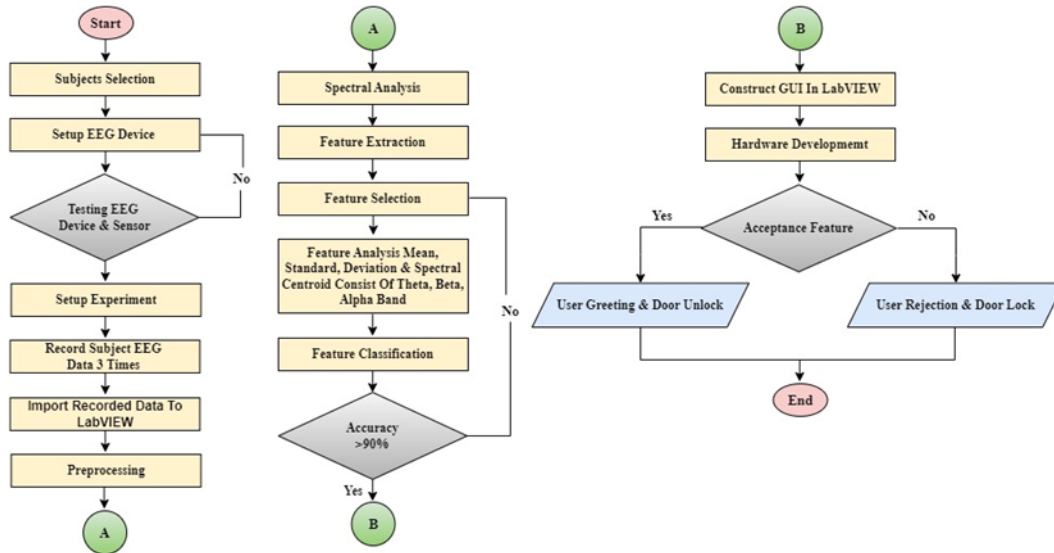

Figure 2. Flowchart of the project

3.2 Subject Selection

A group of six individuals (three males and three females) was chosen for participation in the EEG signal capture sessions; they comprised undergraduate and graduate students, faculty members, and postgraduate students. The age of the participants ranged from 22 to 27 years, and none of them had any prior medical problems. The participants were picked from the Universiti Malaysia Pahang Al-Sultan Abdullah (Pekan campus). The participants were provided with explicit instructions to refrain from ingesting any medications or substances, including alcohol or caffeine, both before and throughout the duration of the investigation.

3.3 EEG Measurement Protocol

Figure 3 represents the EEG device utilized in this project; the Unicorn Hybrid Black EEG device will be employed to capture brain signals by placing it on the subjects' heads. Before the placement, the subjects' scalps will be carefully cleaned using an appropriate solution to eliminate any oils or debris. The electrode placement points for the EEG will be precisely determined based on the Unicorn Black Hybrid user manual to ensure accurate positioning.



Figure 3. EEG signal measuring Unicorn Hybrid Black EEG Device [13]

Conductive gel or paste will be applied to the electrodes to optimize conductivity and minimize impedance. The EEG device's electrodes will be securely and comfortably attached to the designated positions on the subject's scalp, allowing for reliable data acquisition.

EEG measurements will be taken three times under different conditions. In the imaginative condition, subjects will be instructed to close their eyes to minimize data wave interference caused by eye-related disturbances like blinking or twitching. They will be asked to engage in mental activities such as singing a favorite song in their mind or imagining opening a locked door. In the physical condition, subjects will be conscious and required to perform physical movements like playing a mobile game or solving a Rubik's Cube. Figure 4 depicts subjects engaged in these imaginative and physical activities. The EEG device will be set to a sampling frequency of 250 Hz, and data collected will be analyzed using LabVIEW software.



Figure 4. Snapshot of the subject during imaginative and physical activities

3.4 Feature Extraction

In this particular study, the analysis of human brainwaves was performed by using the EEG signal's standard deviation and spectral centroid as parameters. The spectral centroid is calculated by taking the average frequency, weighing it by the sum of the amplitudes, and dividing it by the total amplitude. The formula for calculating the Spectral Centroid is shown below in Equation (1) [14]. On the other hand, standard deviation is a characteristic of statistics that indicates the distribution of data in relation to the mean value of the data. Mean calculated by summing all the EEG sample values in a given time window and dividing by the number of samples in that window, the formula for determining mean is shown in Equation (2). The standard deviation is shown in Equation (3). The equation represents how much the individual data points in a set deviate from the mean of that set. The mean or average and N stands for the total amount of time that the EEG data was collected.

$$\text{Spectral Centroid} = \frac{\int xg(x)dx}{\int g(x)dx} \quad (1)$$

$$\text{Mean} = \frac{1}{N} \sum_{i=1}^N x(i) \quad (2)$$

$$\text{Standard Deviation} = \sqrt{\frac{1}{N-1} \sum_{i=1}^N (X_i - \mu)^2} \quad (3)$$

Standard Deviation, Mean and Spectral Centroid are applied to the power spectrum of EEG Alpha, Beta, and Theta bands in order to understand human behavior. This is done in order to determine a person's cognitive and emotional state. power spectrum and power spectral density are two ways of analyzing the frequency content of an EEG signal. The power spectrum of an EEG signal is the magnitude squared of its Fourier transform and provides information about the power at each frequency component of the signal. It can be calculated using the formula of Equation (4), more details in [15]. Equation (5) is the formula for power spectral density (PSD) [16], the PSD of an EEG signal is a normalized version of the power spectrum and provides a measure of the power per unit of frequency in the signal.

$$\text{Power Spectrum} = \sum_{n=0}^{N-1} x(nTs)e^{-j\pi nk/N} \quad (4)$$

$$\text{PSD} = |X(K)|^2 = \left| \sum_{n=0}^{N-1} X(nTs) = e^{-j\frac{2\pi nk}{N}} \right|^2 \quad (5)$$

3.5 Feature Classification

The k-Nearest Neighbors (KNN) algorithm looks at the distance between the features in a data set to determine which pieces of information belong in which category. When the distance between the data points is somewhat near, one group is formed; when the distance is quite great, however, many groups are formed instead. In other words, the classifier recognizes the KNN in the training data, as given in Equation (6) [17] and allocates groups to instances that occur more frequently in the k neighborhood.

$$d(X_i, X_j) = \sqrt{\sum_i (X_i - X_j)^2} \quad (6)$$

Modifying the value of k is required to determine which class best matches the data used for training and testing. The training and testing data are evaluated using different ratios, specifically 50:50, 70:30, and 80:20. To determine the best approach that can achieve a high accuracy rate, adjustments are made to the default settings of the classifier, including the k value and the training and testing ratio [18]. These modifications aim to optimize the performance and accuracy of the classifier in classifying the data.

3.6 NI myRIO Controller

Figure 5 illustrates the NI myRIO 1900 controller, which is an advanced embedded hardware and software platform that empowers engineers, researchers, and educators in the fields of robotics, mechatronics, and system control. It combines a real-time processor, an FPGA, and integrated I/O interfaces for tackling complex engineering challenges. With its powerful processing capabilities, including a dual-core ARM Cortex-A9 processor and customizable FPGA, the myRIO 1900 enables the implementation of sophisticated algorithms, high-speed data acquisition, and real-time control tasks. It offers a rich set of I/O options, such as analog and digital I/O, and supports communication protocols like Ethernet and USB for seamless integration with sensors and actuators. Complemented by the LabVIEW system design software and myRIO toolkit, it facilitates rapid prototyping and testing. The myRIO 1900 pinouts, as shown in Figure 6, provide versatile connectivity options, including analog inputs, analog outputs, digital I/O, SPI, I2C, PWM, encoder inputs, and power supply pins. In this project, specific pins are allocated for controlling the relay (A0 pin) and connecting the red and green LEDs (DI0 and DI1 pins) for synchronized operation, facilitating user identification and authentication.

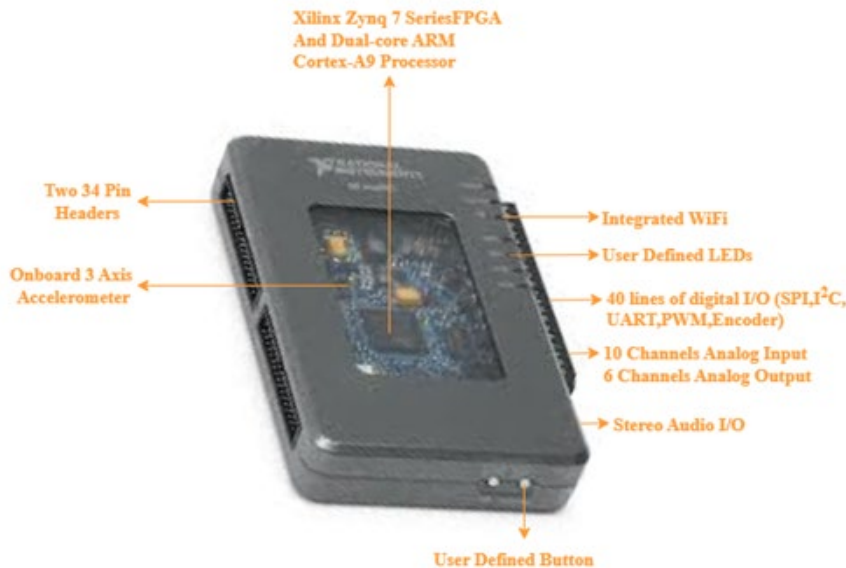

Figure 5. NI myRIO 1900 controller

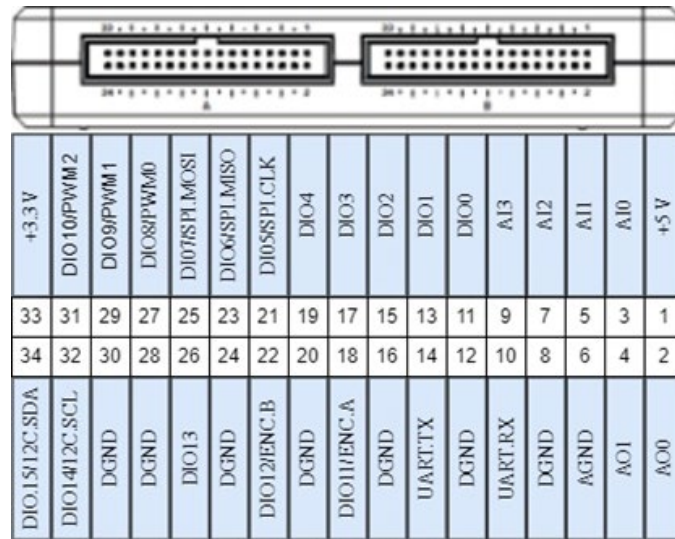

Figure 6. Pinout diagram of NI myRIO 1900 controller

3.7 LabVIEW Programming

LabVIEW, or Laboratory Virtual Instrument Engineering Workbench, is a graphical programming environment widely used in engineering and scientific research. Its intuitive interface, based on a graphical language called G, simplifies complex programming tasks and enables rapid prototyping. Key to LabVIEW is its dataflow paradigm, where execution follows data availability rather than traditional sequential lines of code, empowering users to design efficient and parallel algorithms. With a vast library of pre-built functions and tools known as Virtual Instruments, LabVIEW offers seamless integration with hardware platforms, facilitating real-time control and monitoring. Its versatility and user-friendly nature make LabVIEW an indispensable tool for data analysis, automation, and control in various research domains.

Figure 7 depicts the program implementation for NI myRIO in LabVIEW and Figure 8 is the extensive LabVIEW programming employed throughout the entire project.

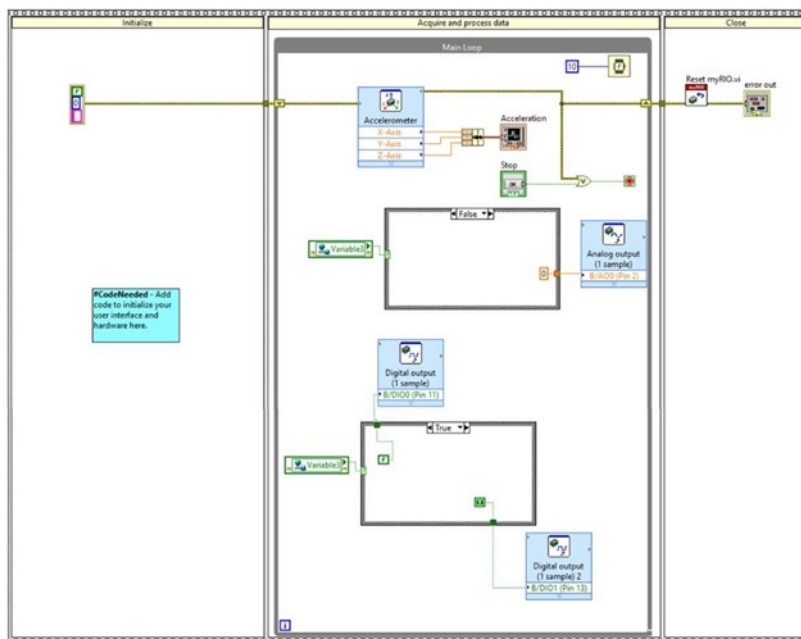

Figure 7. LabVIEW coding for myRIO 1900

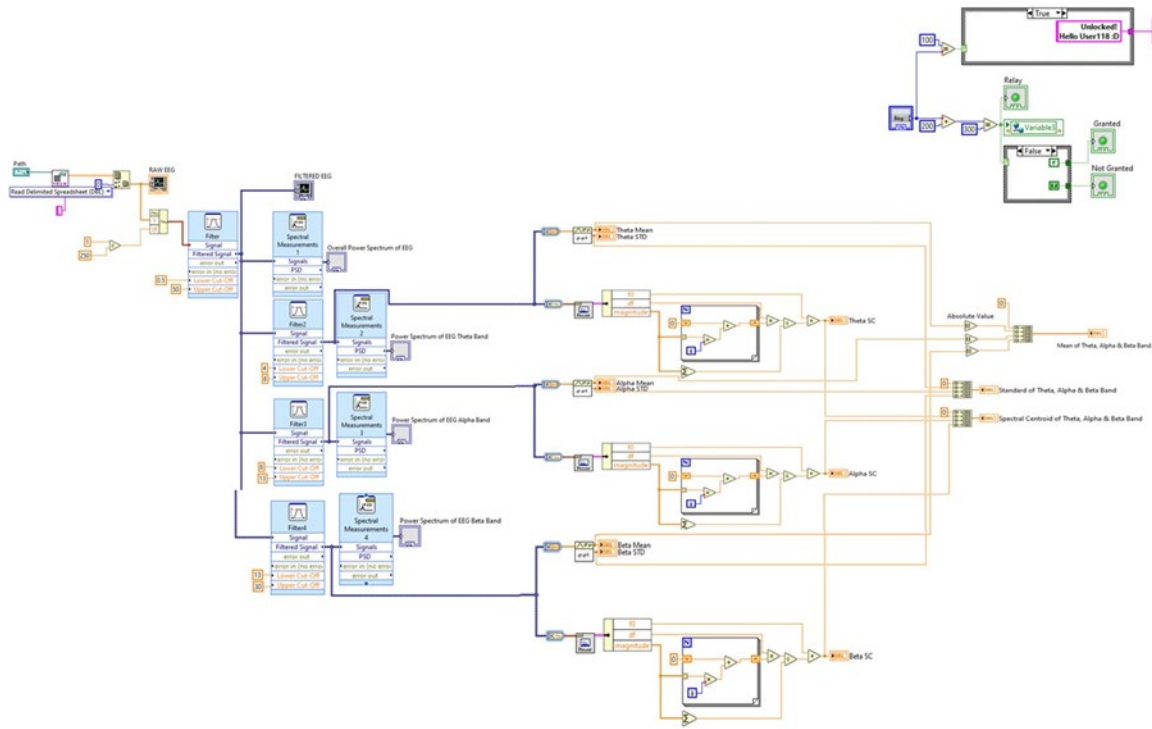

Figure 8. Full programming LabVIEW

3.8 Hardware Circuit Selection

Figure 9 illustrates the circuit schematic of my project. All connections are made on connector B of the NI myRIO. The positive terminal of a red LED is connected to port DIO1, while the positive terminal of a green LED is connected to port DIO0. Both LEDs are connected in series with a 1k ohm resistor to limit the current. The ground terminals of the LEDs and the resistor are connected in parallel and connected to the DGND port of the NI myRIO. For the relay, VCC is connected to the +5V port, GND is connected to the AGND port, and IN is connected to the AO0 port of the NI myRIO. The NC port of the relay is connected to the positive terminal of a 12V battery, and the negative terminal of the battery is connected to the negative side of the door lock solenoid. Finally, the positive side of the door lock solenoid is connected to the COM terminal of the relay.

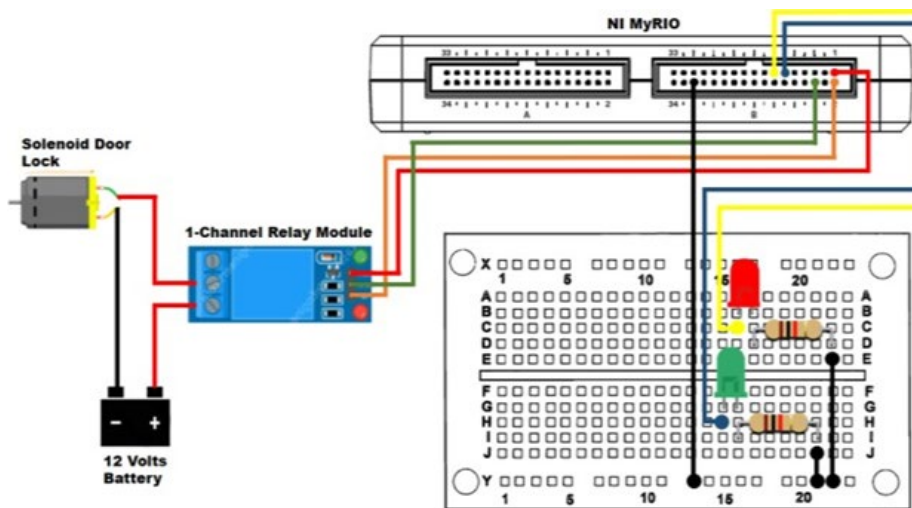

Figure 9. Hardware circuit schematic

4.0 RESULTS

Figure 10(a) is the raw EEG data unprocessed electrical signals captured from the brain. This data is typically noisy and contains artifacts. After pre-processing, the EEG signals are filtered to eliminate unwanted noise and focus on the relevant frequency bands as in Figure 10(b). A commonly used approach is to apply a bandpass filter with specific frequency limits (such as 0.5Hz to 50Hz), to retain the desired brainwave frequencies.

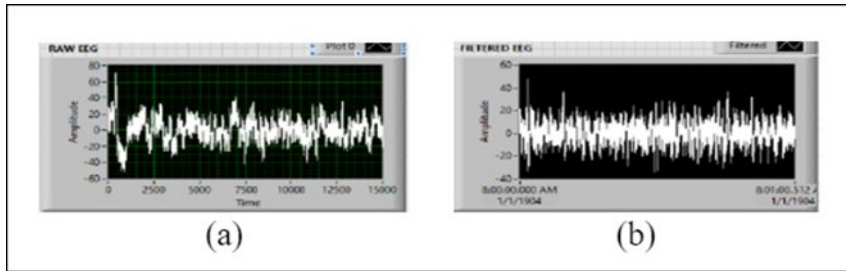

Figure 10. EEG signal from participants; (a) Raw signal and (b) Filtered signal

Figure 11(a) is the overall power spectrum of the EEG representing the distribution of power across the entire frequency range. It provides valuable insights into the dominant frequencies present in the EEG signals and their relative strengths. Figure 11(b) illustrates the power spectrum of the EEG Theta band specifically examines the frequency distribution and power levels within the Theta frequency range around 4Hz to 8Hz. Theta waves are associated with states of relaxation, creativity, and deep meditation. Figure 11(c) depicts the power spectrum of the EEG Alpha band focuses on the frequency range between 8Hz and 13Hz. Alpha waves are often observed when individuals are in a relaxed and calm state, with eyes closed. This band is also associated with attentional processes. Figure 11(d) shows the power spectrum of the EEG Beta band analyses the frequency range around 13Hz to 30Hz. EEG Beta waves are commonly observed during active thinking, concentration, and alertness. Higher beta frequencies may indicate heightened mental activity or stress.

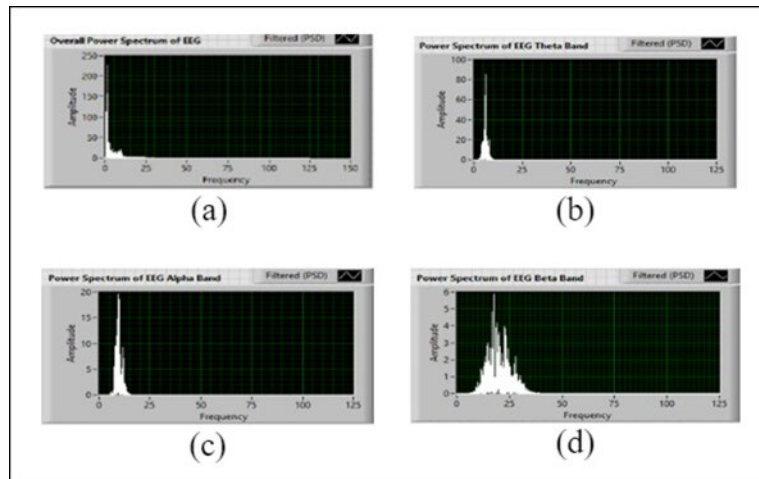

Figure 11. EEG spectrum; (a) Overall; (b) Theta band; (c) Alpha band and (d) Beta band

4.1 EEG Features Of Mean, Standard Deviation and Spectral Centroid

Figure 12 depicts the EEG feature of mean, and Figure 13 represents the EEG feature of standard deviation. The results indicate that the Theta band had a higher mean and standard deviation, suggesting a greater presence of Theta waves in the EEG data. This implies that the subjects may have been in a relaxed or meditative state during the experiment. Figure 14 shows the EEG feature of spectral centroid where the EEG Beta band exhibited a higher spectral centroid, indicating a focus on higher-frequency Beta waves associated with active thinking and concentration.

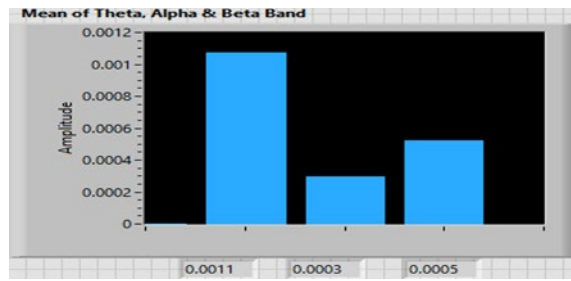

Figure 12. EEG feature of Mean

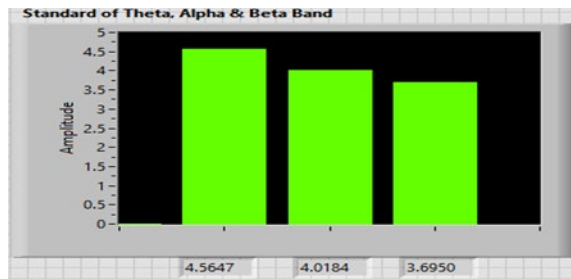

Figure 13. EEG feature of Standard Deviation

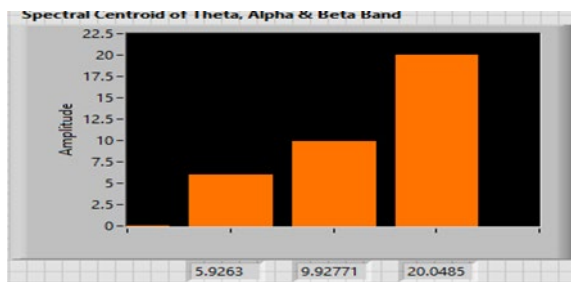

Figure 14. EEG feature of Spectral Centroid

4.2 KNN Classification

Figure 15 illustrates the outcomes of the KNN classification with different training-to-testing data ratios for Mean and Standard Deviation. The accuracy percentages for correct predictions are presented as 83.33%, 80.92%, and 93.35% when the training data-to-testing data ratios are 50:50, 70:30, and 80:20, respectively.

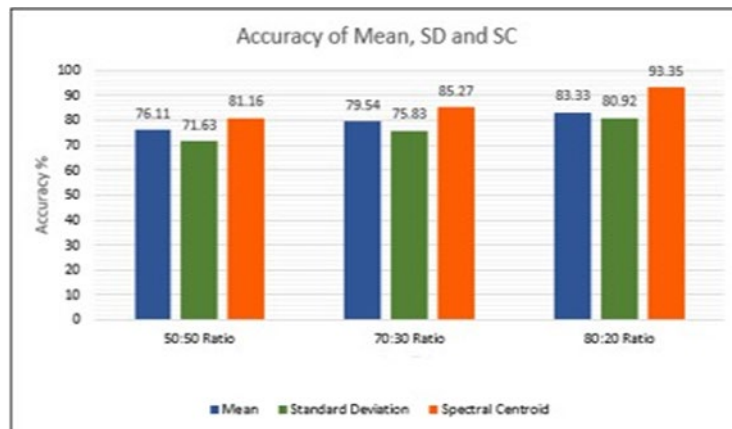

Figure 15. Accuracy utilizing Mean, Standard Deviation and Spectral Centroid

4.3 User Identification And Authentication Indicator

The graphical user interface (GUI) includes a screen that displays the authorization status of the user, indicating whether they have been granted access or not. The GUI also incorporates Red and Green LEDs for visual feedback. Figure

16(a) is the user is not authorized, the Red LED lights up, accompanied by a screen message indicating user rejection or prompting them to try again. Conversely, when the user is authorized as shown in Figure 16(b), the Green LED illuminates, and the screen displays a personalized greeting.

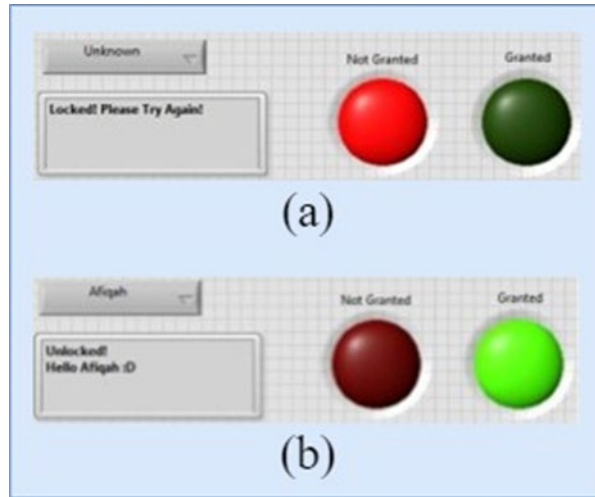

Figure 16. User access: (a) Not granted and (b) Granted

4.4 LabVIEW Graphical User Interface

The LabVIEW software was utilized to develop a comprehensive graphical user interface (GUI) that facilitates user interaction and presents experimental results. Figure 17 shows an overall GUI of the project. Figure 18 indicates that when user access is granted, utilizing specific trained EEG data values that have been preconfigured in the system. This is represented by the illumination of the Green LED, which serves as a visual indicator indicating user authorization and accompanied by the display showing "unlock" and a warm user greeting. Figure 19 elucidates that when access not granted, by uploading random human EEG data values that have not been preconfigured in the system.

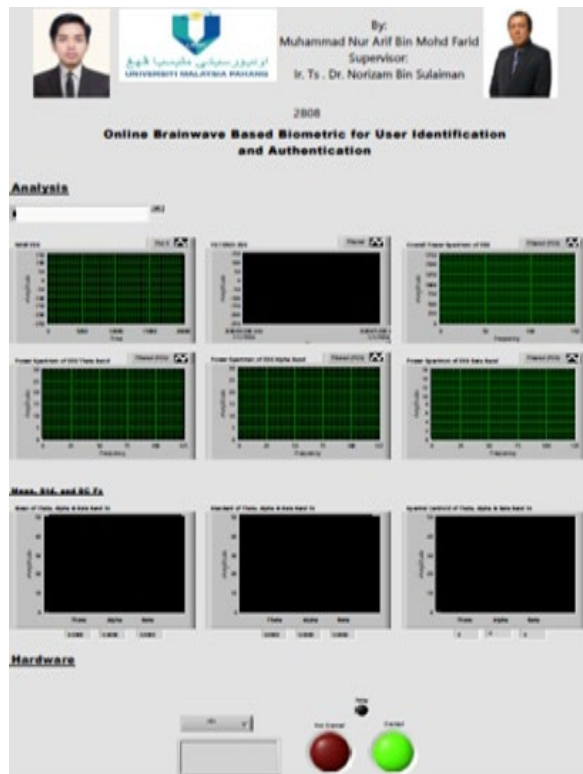

Figure 17. LabVIEW Graphical User Interface (GUI)

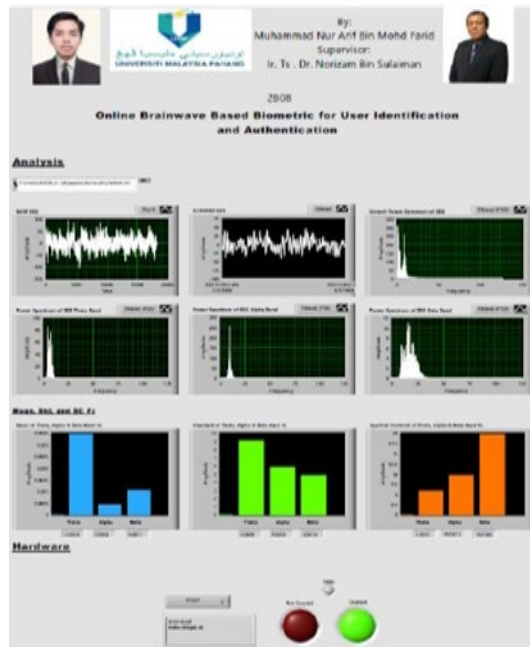

Figure 18. Graphical user interface (GUI) access granted

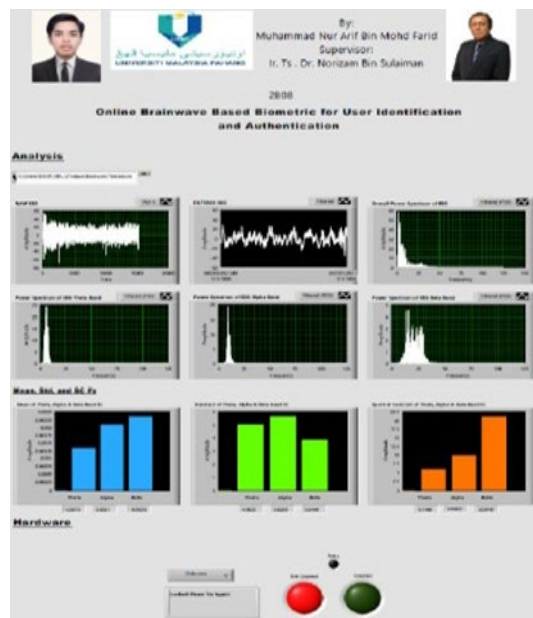

Figure 19. Graphical user interface (GUI) access not granted

4.5 Hardware Development

The hardware setup for user identification and authentication is the utilization of LEDs, a solenoid door lock powered by a 12V battery, and the NI myRIO microcontroller. The NI myRIO is housed inside a box, while the LEDs are positioned on the external front surface of the box. The solenoid door lock is responsible for controlling the opening and closing of the door. The LEDs function as indicators to represent user access authorization. Specifically, a Green LED signifies that the user is granted access and solenoid door lock is open as shown in Figure 20, while a Red LED indicates that access is denied, and solenoid door lock is locked as shown in Figure 21.

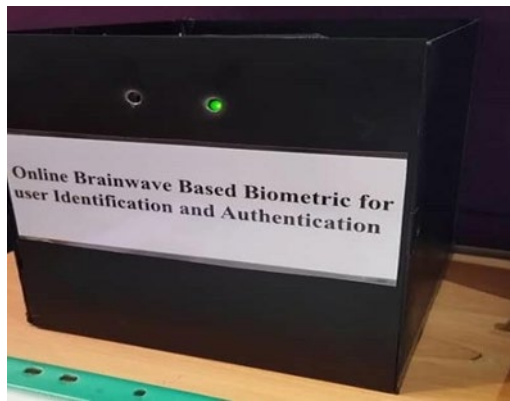

Figure 20. Prototype for access granted

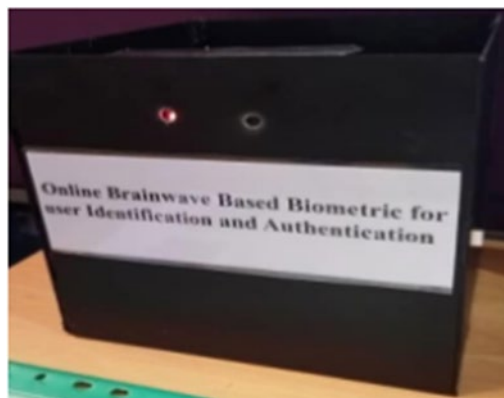

Figure 21. Prototype for access not granted

4.6 Analysis of Mean, Standard Deviation and Spectral Centroid of EEG Signal by Imaginative and Physical Activity

The analyses of the average Mean of EEG by activity are shown in Figure 22, EEG signal analysis during various activities singing favorite music in mind, imagining opening a locked door, playing a mobile game, and playing a Rubik's Cube shows a consistent pattern. The Theta band consistently emerges as the dominant frequency, indicating its crucial role in cognitive and motor processes. Theta band is linked to mental focus, concentration, and cognitive engagement. These results highlight its significance in neural activity during tasks involving imagination, cognition, and motor coordination.

The analyses of the average Spectral Centroid of EEG by activity are shown in the Figure 23. The results reveal that all of these activities exhibit a higher power in the Beta band compared to other frequency bands. This indicates increased neural activity and cognitive engagement during these tasks. The prominence of the EEG Beta band suggests heightened focus, concentration, and mental processing associated with the performed activities.

The analyses of the average Standard Deviation of EEG by activity are shown in the Figure 24. Imaginative tasks like singing favourite music in mind and imagining opening a locked door exhibit higher Alpha band activity, indicating relaxed alertness and mental engagement. Physical tasks like playing a mobile game and solving a Rubik's Cube show higher Theta band activity, indicating increased cognitive engagement, attention, and motor coordination. These findings highlight distinct EEG patterns associated with different activities, suggesting EEG Alpha band predominance in imaginative tasks and Theta band predominance in physical tasks. Understanding these EEG signatures provides insights into cognitive and neural processes during different activities.

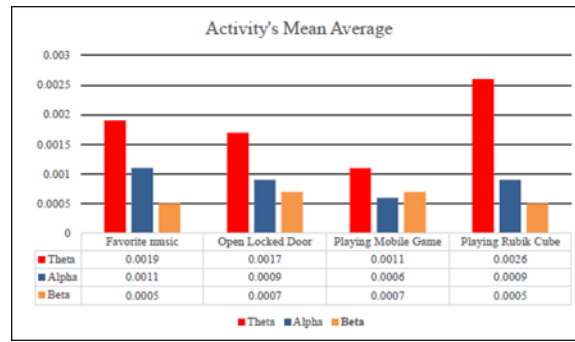

Figure 22. Task wise average Mean of EEG Signal by activity

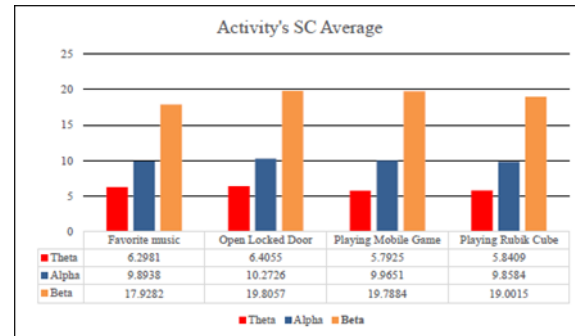

Figure 23. Task wise average Spectral Centroid of EEG Signal by activity

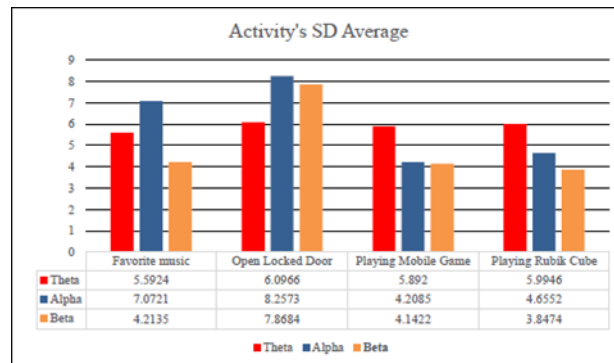

Figure 24. Task wise average Standard Deviation of EEG Signal by activity

5.0 DISCUSSION

This study aimed to create a complete software and hardware system for enhancing biometric user identification and authentication security based on EEG readings. Even though EEG signals can be used to this method, it has some drawbacks, such as the fact that it costs more to run and can cause classifiers to overfit, among other things. To address the difficulties and obtain high classification accuracy, feature extraction methods and a classifier must be utilized. In this study a complete software and hardware system for biometric identification and authentication is presented utilizing some imaginative and physical tasks based on EEG data, with a KNN classification accuracy of 93.35%. The effectiveness of the proposed framework is compared with related research, listed in Table 2.

Table 2. Performance comparison of related studies

Reference	Feature	Result
[7]	Band power	88.33%
[8]	Raw signal	88%
[9]	PSD	79.73%
[19]	Raw ERP	92%
Our proposed framework	Spectral Centroid	93.35%

6.0 CONFLICT OF INTEREST

The authors declare no conflicts of interest.

7.0 ACKNOWLEDGEMENT

The authors would like to thank Faculty of Electrical and Electronics Engineering Technology, Universiti Malaysia Pahang Al-Sultan Abdullah for providing laboratory and financial support for this research under internal grant, RDU210318.

8.0 REFERENCES

- [1] Thomas KP, Vinod AP. EEG-Based Biometric Authentication Using Gamma Band Power During Rest State. *Circuits Syst Signal Process.* 2018 Jan;37(1):277–89.
- [2] Guzel Aydin S, Kaya T, Guler H. Wavelet-based study of valence–arousal model of emotions on EEG signals with LabVIEW. *Brain Inf.* 2016 Jun;3(2):109–17.
- [3] Sahu S, Sharma A. Detecting brainwaves to evaluate mental health using LabVIEW and applications. In: 2016 International Conference on Emerging Technological Trends (ICETT) [Internet]. Kollam, India: IEEE; 2016. p. 1–4. Available from: <http://ieeexplore.ieee.org/document/7873738/>.
- [4] Jalaly Bidgoly A, Jalaly Bidgoly H, Arezoumand Z. A survey on methods and challenges in EEG based authentication. *Computers & Security.* 2020 Jun;93:101788.
- [5] Al-Qazzaz NK, Ali SHBMd, Ahmad SA, Chellappan K, Islam Mds, Escudero J. Role of EEG as Biomarker in the Early Detection and Classification of Dementia. *The Scientific World Journal.* 2014;2014:1–16.
- [6] Thomas KP, Vinod AP. EEG-Based Biometric Authentication Using Gamma Band Power During Rest State. *Circuits Syst Signal Process.* 2018 Jan;37(1):277–89.
- [7] Thomas KP, Vinod AP, Robinson N. Online Biometric Authentication Using Subject-Specific Band Power features of EEG. In: Proceedings of the 2017 International Conference on Cryptography, Security and Privacy [Internet]. Wuhan China: ACM; 2017. p. 136–41. Available from: <https://dl.acm.org/doi/10.1145/3058060.3058068>.
- [8] Ma L, Minett JW, Blu T, Wang WSY. Resting State EEG-based biometrics for individual identification using convolutional neural networks. In: 2015 37th Annual International Conference of the IEEE Engineering in Medicine and Biology Society (EMBC) [Internet]. Milan: IEEE; 2015 [cited 2024 Apr 22]. p. 2848–51. Available from: <https://ieeexplore.ieee.org/document/7318985/>.
- [9] Harshit, Smitha KG, Thomas KP, Vinod AP. Online Electroencephalogram (EEG) based biometric authentication using visual and audio stimuli. In: 2016 IEEE EMBS Conference on Biomedical Engineering and Sciences (IECBES) [Internet]. Kuala Lumpur, Malaysia: IEEE; 2016 [cited 2024 Apr 22]. p. 454–9. Available from: <https://ieeexplore.ieee.org/document/7843492/>.
- [10] Abdulkader SN, Atia A, Mostafa MSM. Brain computer interfacing: Applications and challenges. *Egyptian Informatics Journal.* 2015 Jul;16(2):213–30.
- [11] Hasan MM, Hossain MM, Sulaiman N. Fatigue State Detection Through Multiple Machine Learning Classifiers Using EEG Signal. *Applications of Modelling and Simulation.* 2023;7:178–89.
- [12] Hasan MM, Hossain MM, Sulaiman N, Khandaker S. Microsleep Predicting Comparison Between LSTM and ANN Based on the Analysis of Time Series EEG Signal. *JTEC.* 2024 Mar 31;16(1):25–31.
- [13] UNICORN HYBRID BLACK [Internet]. [cited 2024 Mar 26]. Available from: <https://www.gtec.at/product/unicorn-hybrid-black/>
- [14] Sulaiman N, Taib MN, Lias S, Murat ZH, Aris SAM, Hamid NHA. EEG-based Stress Features Using Spectral Centroids Technique and k-Nearest Neighbor Classifier. In: 2011 UkSim 13th International Conference on Computer Modelling and Simulation [Internet]. Cambridge, United Kingdom: IEEE; 2011. p. 69–74. Available from: <http://ieeexplore.ieee.org/document/5754189/>.
- [15] Dornhege G, Millán J del R, Hinterberger T, McFarland DJ, Müller KR. *Toward Brain-Computer Interfacing.* Vol. 167. MIT Press; 2007.
- [16] Sulaiman N, Goh KS, Rashid M, Jadin S, Mustafa M, Ibrahim MZ, et al. Offline LabVIEW-Based EEG Signals Analysis to Detect Vehicle Driver Microsleep. In: Hassan MHA, Che Muhamed AM, Mohd Ali NF, Lian DKC, Yee KL, Safii NS, et al., editors. *Enhancing Health and Sports Performance by Design* [Internet]. Singapore: Springer Singapore; 2020. p. 271–89. (Lecture Notes in Bioengineering). Available from: http://link.springer.com/10.1007/978-981-15-3270-2_29.
- [17] Isa RM, Pasya I, Taib MN, Jahidin AH, Omar WRW, Fuad N, et al. EEG brainwave behaviour due to RF Exposure using kNN classification. In: 2013 IEEE 3rd International Conference on System Engineering and Technology

- [Internet]. Shah Alam, Malaysia: IEEE; 2013 [cited 2024 Apr 22]. p. 385–8. Available from: <http://ieeexplore.ieee.org/document/6650205/>.
- [18] Mehmood RM, Lee HJ. Emotion classification of EEG brain signal using SVM and KNN. In: 2015 IEEE International Conference on Multimedia & Expo Workshops (ICMEW) [Internet]. Turin, Italy: IEEE; 2015. p. 1–5. Available from: <https://ieeexplore.ieee.org/document/7169786>.
- [19] Armstrong BC, Ruiz-Blondet MV, Khalifian N, Kurtz KJ, Jin Z, Laszlo S. Brainprint: Assessing the uniqueness, collectability, and permanence of a novel method for ERP biometrics. *Neurocomputing*. 2015 Oct;166:59–67.